

Train protection ETCS system ETCS 1 Limited Supervision ETCS System Compatibility Test Description

Document Management

	Name	Signature Date	Signature
Written	Thomas Bastin		
Checked	Thomas Destrée		
Approved	Yves Werner		

This document is the property of Infrabel and contains confidential information. This document may not be reproduced to third parties within or outside Infrabel in any way whatsoever without the written permission of the service Signalling Projects.

History

Author	Version	Date	§ Adapted	Reason
T. Bastin	1.1 draft 1	12/05/2020	/	Creation of the document
T. Bastin	1.1 draft 2	26/05/2020	All	Updated following review of YW and TDe
T. Bastin	1.1	11/06/2020	All	Document release
T. Bastin	1.2 draft 1	06/01/2021	All	Update according to document [1]. New test ESC_L1LS_3 added. Correction: tests ESC_L1LS_1 & 2 inverted.
T. Bastin	1.2	07/01/2021	/	Document release
T. Bastin	1.3 draft 1	17/02/2021	§3.4 and 3.5	Title added
T. Bastin	1.3 draft 2	23/09/2021	§3.6 and 3.7	Transitions ETCS1 LS ↔ ETCS1 LS added
T. Bastin	1.3	07/10/2021	/	Document release
T. Bastin	1.4	15/02/2022	§3.3	Remark added for test ESC_L1LS_3 Document release
T. Destrée	1.5	21/04/2022	§1.1, §1.6.3, §1.7, §3.8, §1.1, §3.10, §3.11.	New test cases for transitions with ETCS2. New testcases for Baseline 2 trains.
T. Bastin	1.6 draft 1	25/10/2022	§1.1, §1.5, §3.12,	New test case for ergonomics in ETCS1 LS. Comments taken into account
T. Bastin	1.6	01/12/2022	/	Document release

Abrogated documents

Name	Version	Date

Distribution of the document

<input type="checkbox"/>	Server	<server id> <path>	
<input type="checkbox"/>	Intranet	<path>	
<input type="checkbox"/>	SharePoint	<name>	
<input type="checkbox"/>	Circular letter	<nr>	
<input type="checkbox"/>	Message	<nr>	
<input type="checkbox"/>	Note	<nr>	
<input type="checkbox"/>	E-mail	<name>	@infrabel.be
		<name>	@<...>
<input type="checkbox"/>	Paper	<name>	<address>

Announce of the publication of the document on intranet

<input type="checkbox"/>	E-mail	<name>@infrabel.be
--------------------------	--------	--------------------

table of Contents

1. INTRODUCTION.....	5
1.1 PURPOSE OF THE DOCUMENT.....	5
1.2 BASIC DOCUMENTS.....	5
1.3 REFERENCE DOCUMENTS.....	5
1.4 ANNEXES.....	5
1.5 SCOPE.....	6
1.6 DEFINITIONS, SYMBOLS AND ABBREVIATIONS.....	6
1.6.1 Definitions.....	6
1.6.2 Symbols.....	6
1.6.3 Abbreviations.....	6
1.7 KNOWN IMPERFECTIONS.....	7
2. ON-BOARD EQUIPMENT.....	7
3. TEST SCENARIOS.....	8
3.1 ESC_L1LS_1: PASSING A CLOSED NON-PERMISSIVE SIGNAL IN LS WITHOUT PRIOR OVERRIDE.....	8
3.1.1 Description.....	8
3.1.2 Scenario diagram.....	9
3.2 ESC_L1LS_2: PASSING A CLOSED NON-PERMISSIVE SIGNAL IN LS WITH PRIOR OVERRIDE.....	10
3.2.1 Description.....	10
3.2.2 Scenario diagram.....	11
3.3 ESC_L1LS_3: RECEPTION OF A PACKET 44 BY A BASELINE 3 TRAIN IN LEVEL NTC (CR1338 NON IMPLEMENTED).....	12
3.3.1 Description.....	12
3.3.2 Scenario diagram.....	13
3.4 ESC_TR_11: TRANSITION ETCS 1 LS TO STM TBL1+.....	14
3.4.1 Description.....	14
3.4.2 Scenario diagram.....	15
3.5 ESC_TR_14 : TRANSITION STM TBL1+ TO ETCS 1 LS.....	16
3.5.1 Description.....	16
3.5.2 Scenario diagram.....	17
3.6 ESC_TR_1 : TRANSITION ETCS 1 FS TO ETCS 1 LS.....	18
3.6.1 Description.....	18
3.6.2 Scenario diagram.....	19
3.7 ESC_TR_3: TRANSITION ETCS 1 LS TO ETCS 1 FS.....	20
3.7.1 Description.....	20
3.7.2 Scenario diagram.....	21
3.8 ESC_TR_2 : TRANSITION ETCS 2 FS TO ETCS 1 LS.....	22
3.8.1 Description.....	22
3.8.2 Scenario diagram.....	24
3.9 ESC_TR_4 : TRANSITION ETCS 1 LS TO ETCS 2 FS.....	25
3.9.1 Description.....	25
3.9.2 Scenario diagram.....	27
3.10 ESC_TR_1_B2 : TRANSITION ETCS 1 FS TO ETCS 1 LS FOR BASELINE 2 TRAINS.....	28
3.10.1 Description.....	28
3.10.2 Scenario diagram.....	30
3.11 ESC_TR_14_B2 : TRANSITION STM TBL1+ TO ETCS 1 LS FOR BASELINE 2 TRAINS.....	31
3.11.1 Description.....	31
3.11.2 Scenario diagram.....	32

3.12 ESC_L1LS_ERG_1: PASSING A SIGNAL WITH A WHITE NUMBER ANNOUNCED BY A SIGNAL PRESENTING AN H ASPECT	33
3.12.1 Description	33
3.12.2 Scenario diagram	34
3.12.3 Note	34

1. Introduction

1.1 Purpose of the document

The purpose of this document is to define the test scenarios to perform in order to:

- prove the ETCS System Compatibility (ESC) between the trackside ETCS Level 1 mode Limited supervision and the On-board.
- prove the On-board equipment reads and reacts according to the TBL1+ information given by the trackside.

The tests scenarios describe more in detail each “high level” scenarios defined in the ESC test plan[1]. The success of these test scenarios shall prove:

- the technical compatibility between ETCS On-board and the Trackside part ETCS of the CCS subsystems within the ETCS 1 LS area on Infrabel conventional network.
- the technical compatibility between On-board baseline 3 and the Trackside part NTC TBL1+.

The technical specification for interoperability used inside an ETCS 1 LS area on Infrabel network is TSI 2016/919 [2] and corrigendum [3], set of specification #3 with system version 2.0.

To allow the standalone TBL1+ and ETCS Baseline 2 On-board to run on the ETCS 1 LS infrastructure, the CR1338 is not implemented. The structure of the P44 is compliant with the TBL1+ and ETCS baseline 2 specifications.

A Test case is foreseen to feel the behavior of the trackside <-> on-board interaction depending on the infrastructure, the calculated braking curves and the driving within the ETCS LS area.

These test scenarios for ETCS system compatibility do not cover all design rules used in an ETCS 1 LS area. If required, Infrabel can provide additional operational test scenarios performed during the verification that the trackside subsystem complies with the requirement of the TSI [2]&[3].

In case of doubt concerning the ESC of the board with the trackside, the railway undertaking shall take the required action with his supplier and inform Infrabel.

1.2 Basic documents

Ref.	Title	Owner
[1]	PSI (TC,ETCSsys,z) ESC TST PLN	Infrabel

1.3 Reference documents

Ref.	Title	Owner
[2]	COMMISSION REGULATION (EU) 2016/919 of 27 May 2016	UE
[3]	Corrigendum to Commission Regulation (EU) 2016/919 of 27 May 2016	UE
[4]	COMMISSION IMPLEMENTING REGULATION (EU) 2019/776 of 16 May 2019	UE

1.4 Annexes

Ref.	Title	Owner
[5]	/	/

1.5 Scope

This document is applicable for all trains would run in an ETCS 1 LS area on the Infrabel conventional network.

The tested functionalities are described in the table here under:

Test scenario (ref ESC TST PLN [1])	Tested functionality
ESC_L1LS_1	Override of a closed main stop signal without application of the override procedure
ESC_L1LS_2	Override of a closed main stop signal with application of the override procedure
ESC_L1LS_3	Reception of a packet 44 by a Baseline 3 train in level NTC (CR1338 non implemented)
ESC_TR_11	Transition ETCS 1 LS to STM TBL1+
ESC_TR_14	Transition STM TBL1+ to ETCS 1 LS
ESC_TR_1	Transition ETCS 1 FS to ETCS 1 LS
ESC_TR_2	Transition ETCS 2 FS to ETCS 1 LS
ESC_TR_3	Transition ETCS 1 LS to ETCS 1 FS
ESC_TR_4	Transition ETCS 1 LS to ETCS 2 FS
ESC_L1LS_Erg_1	Passing a signal with a white number announced by a signal presenting an H aspect

Some other functionalities are also verified during these scenarios:

- Display of the LSSMA at double yellow aspect (ESC_L1LS_1)
- Display of the release speed (ESC_L1LS_1)

Most of the test cases concern baseline 3 trains. Two additional test cases concern Baseline 2 trains to validate the management of VBC and M_VERSION 2 BG's by Baseline 2 trains.

The document will only describe the sequences to perform the scenarios but not all the actions to prepare the execution of the test scenarios.

1.6 Definitions, symbols and abbreviations

1.6.1 Definitions

/

1.6.2 Symbols

/

1.6.3 Abbreviations

CCS	Control Command System
DMI	Driver Machine Interface
ESC	ETCS System Compatibility
ETCS	European Train Control System
LGLJM	Reminder Yellow lamp
LS	Limited Supervision
NV	National Values
TSI	Technical Specification for Interoperability
2Y	Aspect wo yellow displayed by the signal

RNP	Aspect Red not permissive displayed by the signal
SME	Session Management Establishment
VBC	Virtual Balise Cover

1.7 Known imperfections

Test scenarios listed below can be performed with electrical trains when an infrastructure (trackside) will be available.

2. On-board Equipment

Out of scope of railway manager Infrabel.

3. Test scenarios

3.1 ESC_L1LS_1: Passing a closed non-permissive signal in LS without prior override

3.1.1 Description

ID	Date	Location / Line		
ESC_L1LS_1	dd/mm/yyyy	<Line>		
Description	Functionality tested : - Override of a closed non-permissive main stop signal without application of the override procedure.			
Signal passed				
Name	Trackside datafile in service			
S1_RNP : <Signal name with aspect RNP>				
Test Scenarios				
Starting condition	Level 1			
	Mode : Limited Supervision			
	National Values ETCS 1 LS used by the train			
	Be sure all authorisations are filled in before performing the test scenarios			
Sequences of the test scenario				
Step	Step description	Description of what to be tested	Statement	Comment
1	Overpassing the closed signal S1_RNP without application of the override procedure.	When overpassing S1_RNP , the train transits to trip mode and stops.	Pass / Fail	
Test scenario ESC_L1LS_1 finished				

3.1.2 Scenario diagram

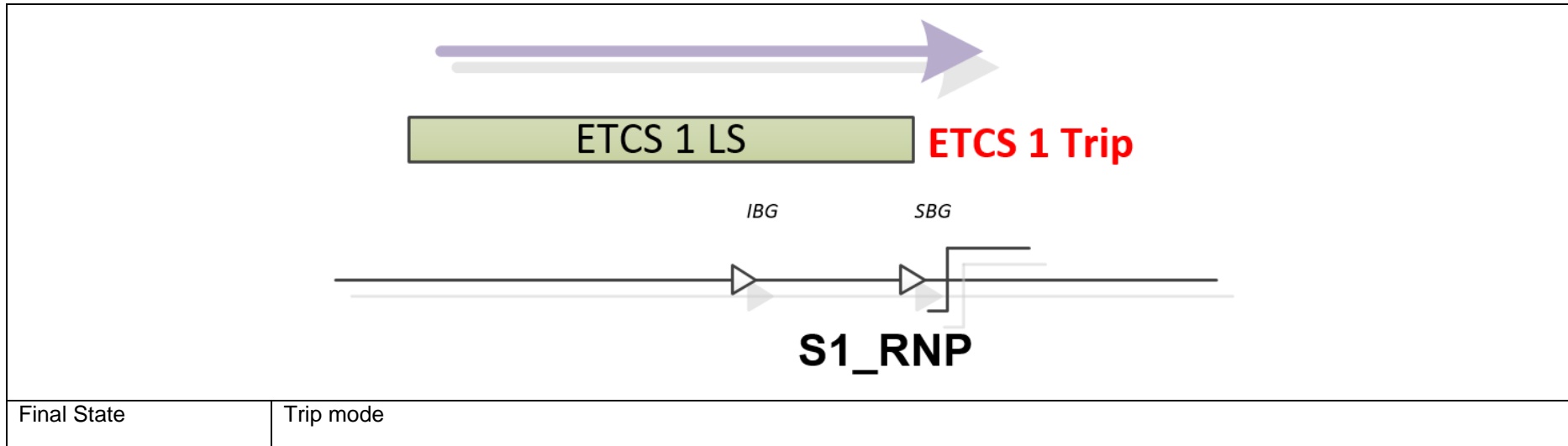

3.2 ESC_L1LS_2: Passing a closed non-permissive signal in LS with prior override

3.2.1 Description

ID		Date			Location / Line	
ESC_L1LS_2		<dd/mm/yyyy>			<Line>	
Description		Functionalities tested : - Display of the LSSMA at double yellow aspect - Display of the release speed - Override of a closed non-permissive main stop signal with application of the override procedure.				
Signal passed						
Name				Trackside datafile in service		
S1_2Y : <Signal name with aspect 2Y>						
S2_RNP : <Signal name with aspect RNP>						
Test Scenarios						
Starting condition		ETCS Level 1				
		Mode : Limited Supervision				
		National Values ETCS 1 LS used by the train				
		Be sure all authorisations are filled in before performing the test scenarios				
Sequences of the test scenario						
Step	Step description	Description of what to be tested	Statement	Comment		
1	Overpassing of the signal S1_2Y with double yellow aspect	When the signal is overpassed, LSSMA (0) is displayed on the DMI	Pass / Fail			
2	Approaching of the signal S2_RNP with red not permissive aspect.	The release speed is displayed on the DMI.	Pass / Fail			
3	Overpassing of the closed signal S2_RNP with application of the override procedure.	Start the override procedure, the train is in Staff Responsible mode and overpasses the closed signal. When reading the SBG of S2_RNP , the train keeps on proceeding in SR.	Pass / Fail			
Test scenario ESC_L1LS_2 finished						

3.2.2 Scenario diagram

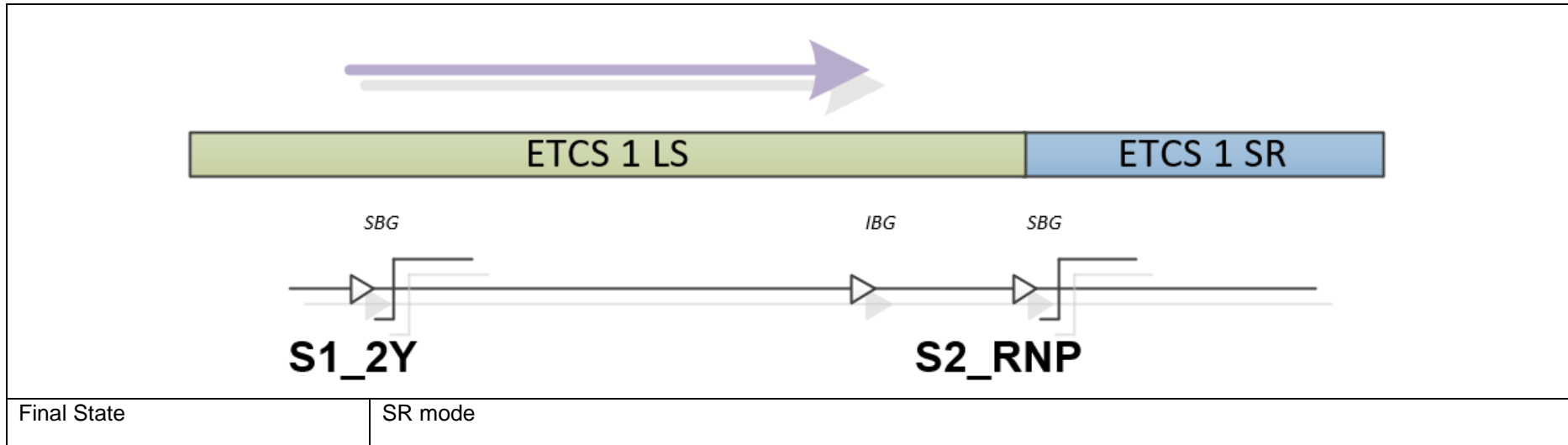

3.3 ESC_L1LS_3: Reception of a packet 44 by a Baseline 3 train in level NTC (CR1338 non implemented)

Remark: The test ESC_L1LS_3 may be not applicable for on-board systems equipped with EVC ETCS and STM TBL1+ separated communicating with a standardized interface. When this is the case, the railway undertaking must contact Infrabel.

3.3.1 Description

ID		Date		Location / Line	
ESC_L1LS_3		<dd/mm/yyyy>		<Line>	
Description		Functionalities tested : - Baseline 3 On board equipment reads and reacts according to TBL1+ information given by a baseline 3 infrastructure . (P44 designed according to TBL1+ and baseline 2 specifications)			
Signal passed					
Name			Trackside datafile in service		
S1_2Y : <Signal name with aspect 2Y>					
Test Scenarios					
Starting condition		NTC Level			
		TBL1+			
		Yellow lamp "LGLJM" off			
Be sure all authorisations are filled in before performing the test scenarios					
Sequences of the test scenario					
Step	Step description	Description of what to be tested		Statement	Comment
1	Overpassing of the signal S1_2Y with double yellow aspect	When the signal is overpassed, the TBL1+ yellow lamp is lit on board.		Pass / Fail	
Test scenario ESC_L1LS_3 finished					

3.3.2 Scenario diagram

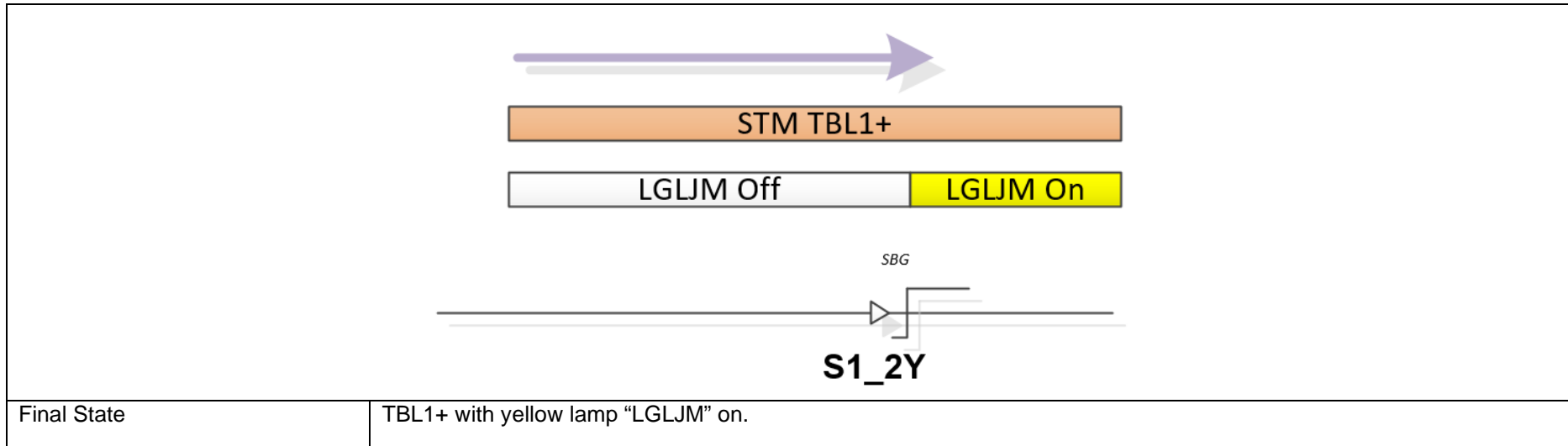

3.4 ESC_TR_11: Transition ETCS 1 LS to STM TBL1+

3.4.1 Description

ID		Date	Location / Line	
ESC_TR_11		dd/mm/yyyy	<Line>	
Description		Functionality tested : - Transition ETCS 1 LS to TBL1+ This test case only applies for a Baseline 3 train.		
Signal passed				
Name		Trackside datafile in service		
S0_ETCS1 LS : <Last Signal in ETCS 1 LS				
S1_TBL1+ : <First signal equipped with TBL1+ only>				
Test Scenarios				
Starting condition		ETCS Level 1		
		Mode : Limited Supervision		
		National Values ETCS 1 LS used by the train		
		Train overpasses signal S0_ETCS1 LS in ETCS 1 LS		
		Be sure all authorisations are filled in before performing the test scenarios		
Sequences of the test scenario				
Step	Step description	Description of what to be tested	Statement	Comment
1	In front of S1_TBL1+ reception of the announcement of the level transition	The announcement is displayed on the screen with a sound and the driver shall acknowledge the transition;	Pass / Fail	
2	In front of S1_TBL1+ , the execution of the transition occurs	The train proceed his movement in STM TBL1+ just before and after overpassing S1_TBL1+ .	Pass / Fail	
Test scenario ESC_TR_11 finished				

3.4.2 Scenario diagram

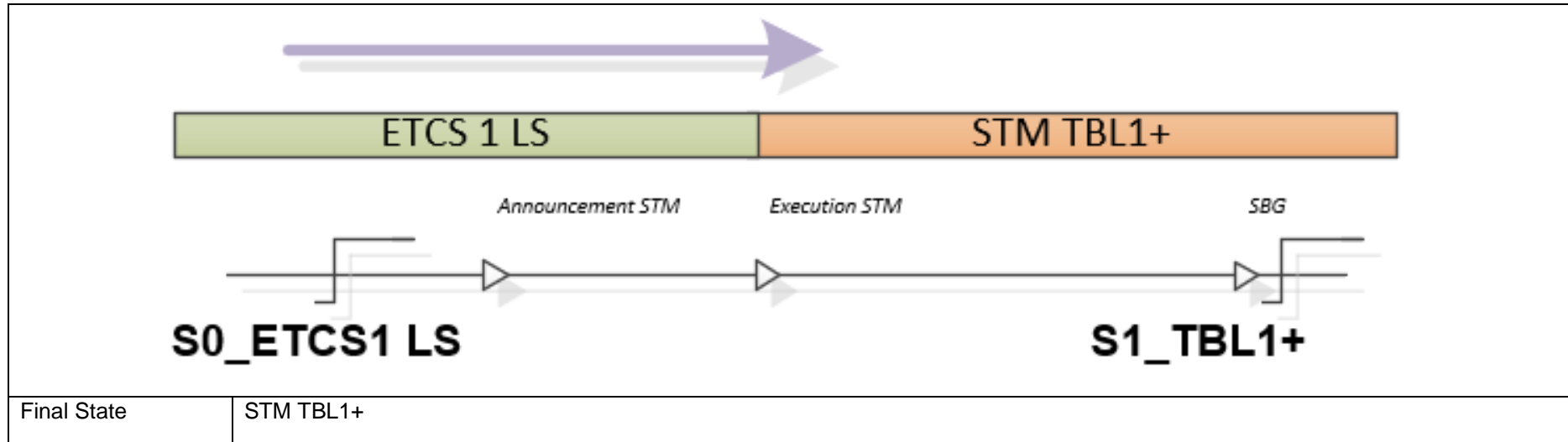

3.5 ESC_TR_14 : Transition STM TBL1+ to ETCS 1 LS

3.5.1 Description

ID		Date		Location / Line	
ESC_TR_14		<dd/mm/yyyy>		<Line>	
Description		Functionalities tested : - Transition STM TBL1+ to ETCS 1 LS This test case only applies for a Baseline 3 train.			
Signal passed					
Name			Trackside datafile in service		
S0_TBL1+ : <Last Signal in TBL1+>					
S1_ETCS1 LS : <First transition Signal in ETCS 1 LS>					
Test Scenarios					
Starting condition		STM TBL1+			
		Train overpasses signal S0_TBL1+ in STM TBL1+			
		Be sure all authorisations are filled in before performing the test scenarios			
Sequences of the test scenario					
Step	Step description	Description of what to be tested	Statement	Comment	
1	In front of S1_ETCS1 LS , reception of the announcement of the transition to Level 1 ETCS	The message is displayed on the DMI with a sound and the driver shall acknowledge the transition message	Pass / Fail		
2	In front of S1_ETCS1 LS , the execution of the level transition occurs, and the driver shall acknowledge the Limited supervision mode	The message for the transition to Limited supervision is displayed on the DMI with a sound and the driver shall acknowledge the message	Pass / Fail		
Test scenario ESC_TR_14 finished					

3.5.2 Scenario diagram

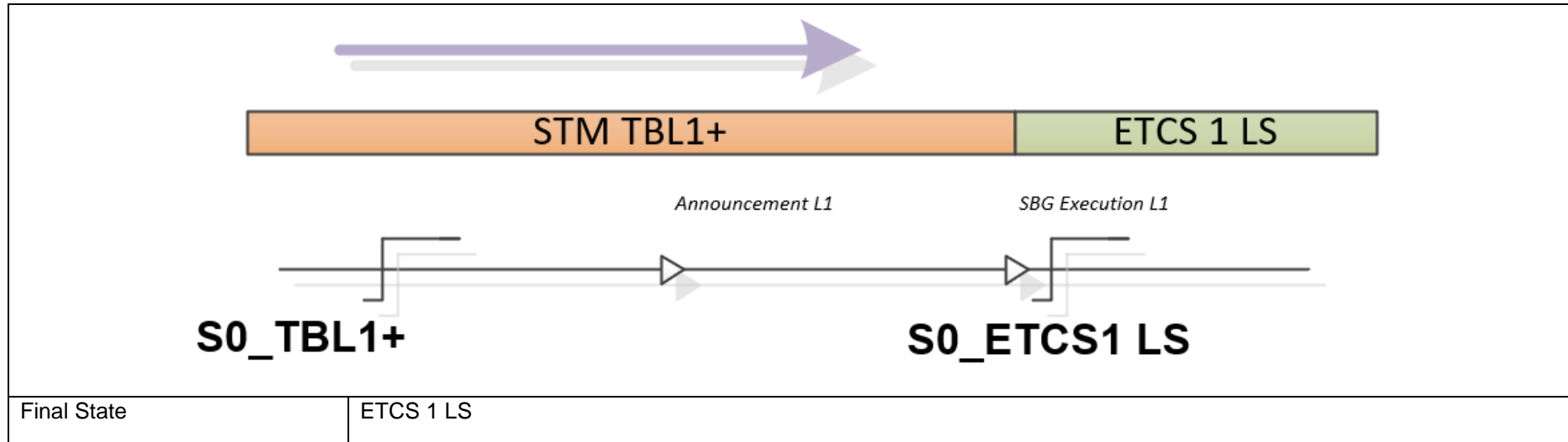

3.6 ESC_TR_1 : Transition ETCS 1 FS to ETCS 1 LS

3.6.1 Description

ID		Date		Location / Line	
ESC_TR_1		<dd/mm/yyyy>		<Line>	
Description		Functionalities tested : - Transition ETCS 1 FS to ETCS 1 LS This test case only applies for a Baseline 3 train.			
Signal passed					
Name			Trackside datafile in service		
S0_ETCS1 FS : <Last Signal in ETCS 1 FS>					
S1_ETCS1 LS : <First transition Signal in ETCS 1 LS>					
Test Scenarios					
Starting condition		ETCS Level 1			
		Mode : Full Supervision			
		National Values ETCS 1 FS used by the train			
		Train overpasses signal S0_ETCS1 FS in ETCS 1 FS			
		Be sure all authorisations are filled in before performing the test scenarios			
Sequences of the test scenario					
Step	Step description	Description of what to be tested	Statement	Comment	
1	Upwards of S1_ETCS1 LS , reception of the text message "END CAB" when driving in VNS or "END CAD =>S*" when driving in CVT.	The message is displayed on the DMI with a sound and the driver shall acknowledge the message used to inform the driver the end of the cab signalling.	Pass / Fail		
2	In front of S1_ETCS1 LS , the execution of the mode transition occurs, and the driver shall acknowledge the Limited supervision mode	The message for the transition to Limited supervision is displayed on the DMI with a sound and the driver shall acknowledge the message	Pass / Fail		
Test scenario ESC_TR_1 finished					

3.6.2 Scenario diagram

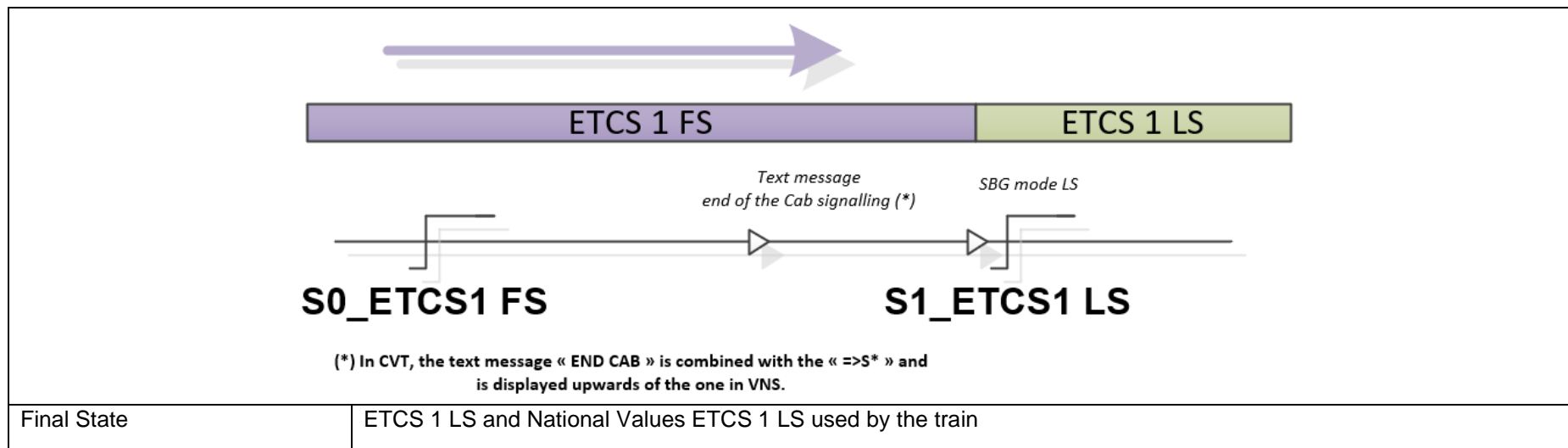

3.7 ESC_TR_3: Transition ETCS 1 LS to ETCS 1 FS

3.7.1 Description

ID	Date	Location / Line		
ESC_TR_3	dd/mm/yyyy	<Line>		
Description	Functionality tested : - Transition ETCS 1 LS to ETCS 1 FS This test case only applies for a Baseline 3 train.			
Signal passed				
Name		Trackside datafile in service		
S0_ETCS1 LS : <Last Signal in ETCS 1 LS				
S1_ETCS1 FS : <First signal equipped with ETCS 1 FS>				
Test Scenarios				
Starting condition		ETCS Level 1		
		Mode : Limited Supervision		
		National Values ETCS 1 LS used by the train		
		Train overpasses signal S0_ETCS1 LS in ETCS 1 LS		
		Be sure all authorisations are filled in before performing the test scenarios		
Sequences of the test scenario				
Step	Step description	Description of what to be tested	Statement	Comment
1	Upwards of the S1_ETCS1 FS	The train proceed his movement in Level 1 mode Limited Supervision	Pass / Fail	
2	When overpassing S1_ETCS1 FS , the driving mode changes	The driving mode of the train changes directly to mode Full Supervision.	Pass / Fail	
Test scenario ESC_TR_3 finished				

3.7.2 Scenario diagram

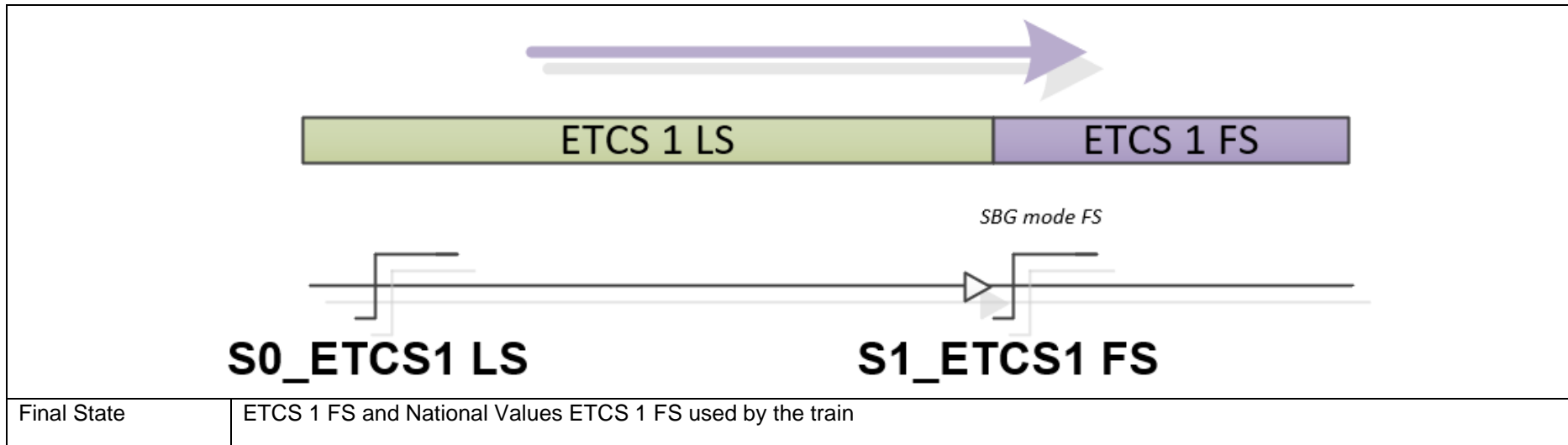

3.8 ESC_TR_2 : Transition ETCS 2 FS to ETCS 1 LS

3.8.1 Description

ID	Date			Location / Line
ESC_TR_2	<dd/mm/yyyy>			<Line>
Description	Functionalities tested : - Transition ETCS 2 FS to ETCS 1 LS This test case only applies for a Baseline 3 train.			
Signal passed				
Name	Trackside datafile in service			
S0_ETCS2 FS : <Last Signal in ETCS 2 FS>				
S1_ETCS1 LS : <First transition Signal in ETCS 1 LS on normal track (VNS)>				
Test Scenarios				
Starting condition	ETCS Level 2			
	Mode : Full Supervision			
	National Values for Full Supervision are used by the train			
	Train upwards S0_ETCS2 FS			
	Signals S0_ETCS2 FS and S1_ETCS1 LS are open.			
Be sure all authorisations are filled in before performing the test scenarios				
Sequences of the test scenario				
Step	Step description	Description of what to be tested	Statement	Comment
1	Train passes S0_ETCS2 FS signal	Train continues in ETCS2 FS.	Pass / Fail	
2	Train passes the VBCon BG	a) Train receives a packet 200. b) Train continues in ETCS2 FS	Pass / Fail	
3	Train passes AnnSTM BG and ExeSTM BG.	a) Train rejects the telegrams of the BG's because of VBC. b) Train continues in ETCS2 FS	Pass / Fail	
4	Train passes the Text BG.	a) The DMI displays « END CAB » and requires acknowledgement. b) Train continues in ETCS 2 FS.	Pass / Fail	
5	Driver acknowledges the text message.	a) Train continues in ETCS2 FS	Pass / Fail	

6	Train passes the SBG of the S1_ETCS1 LS signal.	<ul style="list-style-type: none"> a) Train changes to ETCS1 LS mode. b) National values for ETCS1 LS are registered on board. 	Pass / Fail	
7	Driver acknowledges the LS mode	Train continues in LS mode.	Pass / Fail	
Test scenario ESC_TR_2 finished				

3.8.2 Scenario diagram

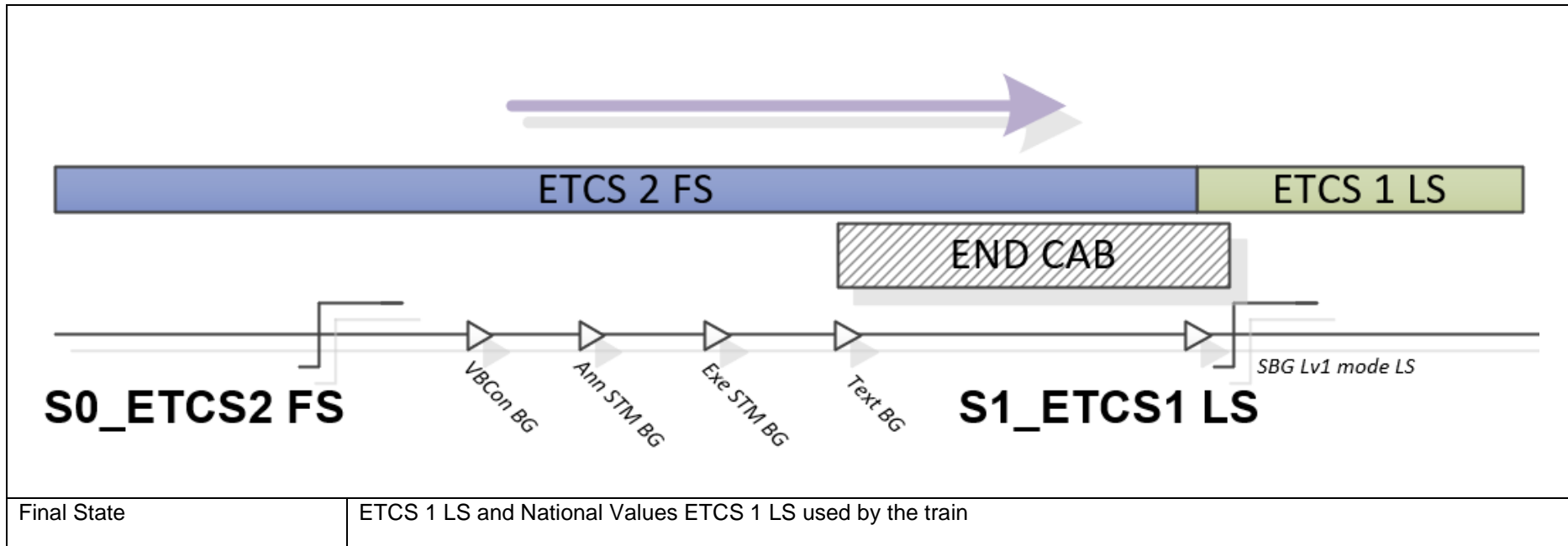

3.9 ESC_TR_4 : Transition ETCS 1 LS to ETCS 2 FS

3.9.1 Description

ID	Date	Location / Line		
ESC_TR_4	<dd/mm/yyyy>	<Line>		
Description	Functionalities tested : - Transition ETCS 1 LS to ETCS 2 FS This test case only applies for a Baseline 3 train.			
Signal passed				
Name		Trackside datafile in service		
S0_ETCS1 LS : <Last ETCS1 LS signal>				
S1_ETCS2 FS : <First transition Signal in ETCS 2 FS>				
Test Scenarios				
Starting condition	ETCS Level 1			
	Mode : Limited Supervision			
	National Values ETCS 1 LS used by the train			
	Train is upwards S0_ETCS1 LS and SME BG. The radio network registration information (P45) is stored onboard.			
	All signals are open.			
Be sure all authorisations are filled in before performing the test scenarios				
Sequences of the test scenario				
Step	Step description	Description of what to be tested	Statement	Comment
1	Train passes SME BG (sending P42) and S0_ETCS1 LS (The SME BG could be pass before or after S0_ETCS1 LS).	a) Train establishes a session with the RBC. b) Train remains in ETCS1 Limited Supervision.	Pass / Fail	
2	Train passes NV BG's.	a) Train receives a message containing packet 3 (with M_VERSION 1). The national values are stored on board and the values corresponding to the packet 203 are not modified.	Pass / Fail	

		<ul style="list-style-type: none"> b) Train sends position report to the RBC. c) DMI shows a level transition announcement to Level 2 and require acknowledgment. d) Train remains in ETCS 1 Limited Supervision. 		
3	Driver acknowledges the level transition.	Train remains in ETCS1 Limited supervision	Pass / Fail	
4	Train passes signal S1_ETCS2 FS.	<ul style="list-style-type: none"> a) After ±60 meters, train changes to level 2 Full supervision. b) No brakes are applied. c) The national values for Full Supervision are stored onboard, including the values corresponding to the P203. 	Pass / Fail	
Test scenario ESC_TR_4 finished				

3.9.2 Scenario diagram

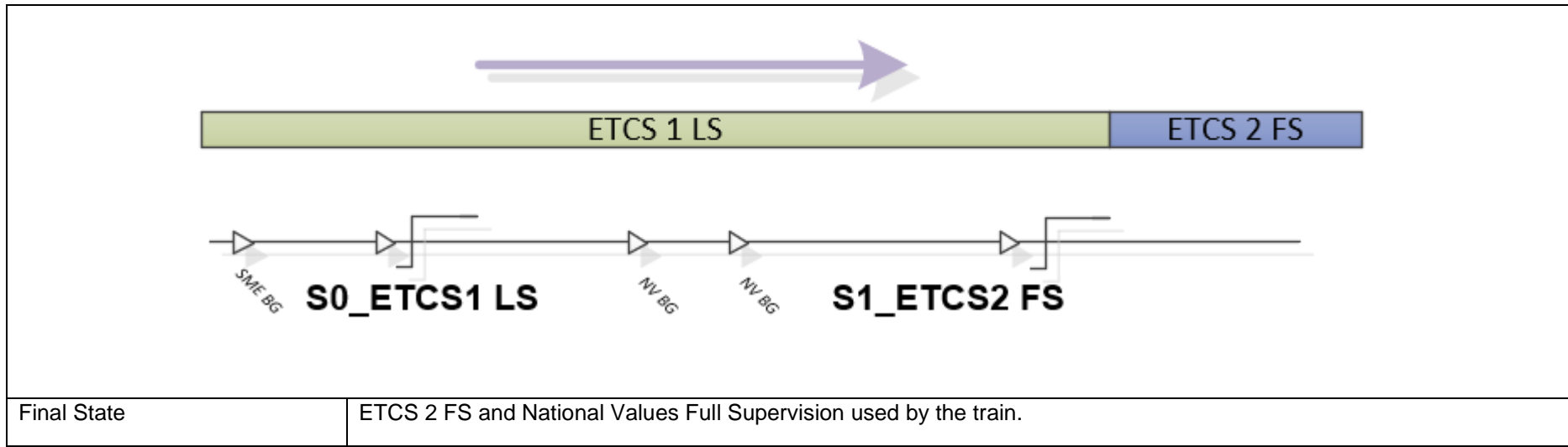

3.10 ESC_TR_1_B2 : Transition ETCS 1 FS to ETCS 1 LS for Baseline 2 trains

3.10.1 Description

ID	Date	Location / Line		
ESC_TR_1_B2	<dd/mm/yyyy>	<Line>		
Description	Functionalities tested : - Transition ETCS 1 FS to STM at the entry of a LS area This test case only applies for a Baseline 2 train.			
Signal passed				
Name		Trackside datafile in service		
S0_ETCS1 FS : <Last Signal in ETCS 1 FS>				
S1_ETCS1 LS : <First transition Signal in ETCS 1 LS>				
Test Scenarios				
Starting condition	ETCS Level 1			
	Mode : Full Supervision			
	National Values ETCS 1 FS used by the train			
	Train upwards signal S0_ETCS 1 FS in ETCS 1 FS			
	All signals are open			
Be sure all authorisations are filled in before performing the test scenarios				
Sequences of the test scenario				
Step	Step description	Description of what to be tested	Statement	Comment
1	Train passes S0_ETCS1 FS signal	Train continues in ETCS1 FS.	Pass / Fail	
2	Train passes the VBCon BG	a) Train receives a packet 200 and reject it. b) Train continues in ETCS1 FS	Pass / Fail	
3	Train passes AnnSTM BG	a) DMI shows a level transition announcement to level STM b) DMI requires an acknowledgment c) Train continues in ETCS1 FS.	Pass / Fail	
4	Driver acknowledges the level transition.	a) Train continues in ETCS1 FS.	Pass / Fail	
5	Train passes ExeSTM BG	a) Train changes to STM TBL1+.	Pass / Fail	

		b) No brakes are applied.		
6	Train passes the SBG of the S1_ETCS1 LS signal.	a) Train continues in STM TBL1+.	Pass / Fail	
Test scenario ESC_TR_1_B2 finished				

3.10.2 Scenario diagram

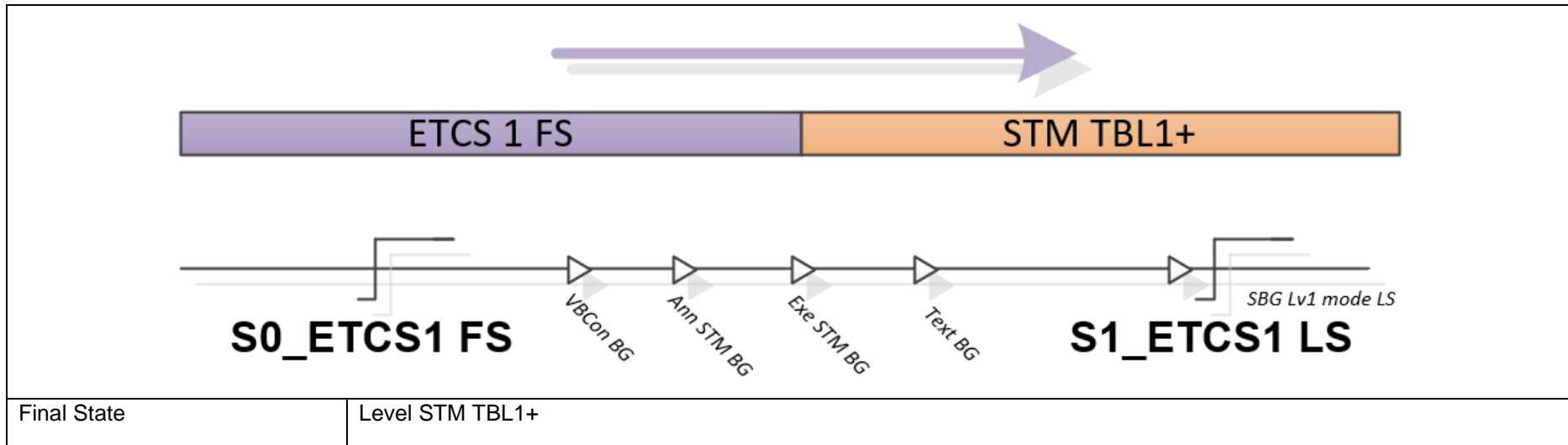

3.11 ESC_TR_14_B2 : Transition STM TBL1+ to ETCS 1 LS for Baseline 2 trains

3.11.1 Description

ID	Date	Location / Line		
ESC_TR_14_B2	<dd/mm/yyyy>	<Line>		
Description	Functionalities tested : - Absence of transition at the entry of a ETCS 1 LS area. This test case only applies for a Baseline 2 train.			
Signal passed				
Name		Trackside datafile in service		
S0_TBL1+ : <Last Signal in TBL1+>				
S1_ETCS1 LS : <First transition Signal in ETCS 1 LS>				
Test Scenarios				
Starting condition		STM TBL1+ Train upwards signal S0_TBL1+ in STM TBL1+ S0_TBL1+ is open. S1_ETCS1 LS shows double yellow aspect. Be sure all authorisations are filled in before performing the test scenarios		
Sequences of the test scenario				
Step	Step description	Description of what to be tested	Statement	Comment
1	Train passes S0_TBL1+	Train continues in STM TBL1+.	Pass / Fail	
2	Train passes the Announcement L1 BG.	a) Train receives telegrams with M_VERSION = 32. b) Train continues in STM TBL1+. c) No brakes are applied.	Pass / Fail	
3	Train passes S1_ETCS1 LS .	a) Train receives telegrams with M_VERSION = 32. b) TBL1+ yellow lamp lights up. c) Train continues in STM TBL1+. d) No brakes are applied.	Pass / Fail	
Test scenario ESC_TR_14_B2 finished				

3.11.2 Scenario diagram

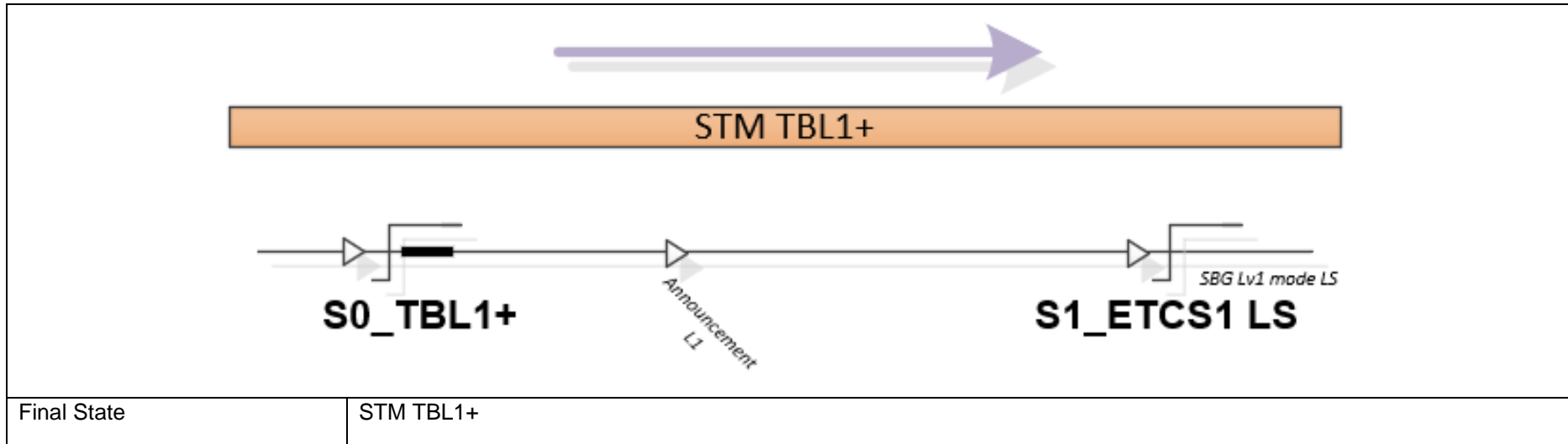

3.12 ESC_L1LS_Erg_1: Passing a signal with a white number announced by a signal presenting an H aspect

3.12.1 Description

ID	Date	Location / Line		
ESC_L1LS_Erg_1	dd/mm/yyyy	<Line>		
Description	Behavior of the trackside <-> on-board interaction depending on the infrastructure, the calculated braking curves and the way to drive. The braking curves defined in the subset 26 create a speed limitation onboard upwards the actual restriction of the MRSP. This test intends to ensure the length of this additional speed limitation allows the driver to ride according to the lateral signaling.			
Signal passed				
Name		Trackside datafile in service		
S1_H : <Signal name with aspect H>				
S2_Gx : Signal name with aspect G and white number (x).				
Test Scenarios				
Starting condition		Level 1		
		Mode : Limited Supervision		
		National Values ETCS 1 LS used by the train		
		Be sure all authorisations are filled in before performing the test scenarios		
Sequences of the test scenario				
Step	Step description	Description of what to be tested	Statement	Comment
1	Passing the signal S1_H in “normal” driving	The train is in L1 LS mode	Pass / Fail	
2	Respect the driving in lineside signaling to approach the S2_Gx	The train is not braked in normal driving	Pass / Fail	
3	The signal S2_Gx is passed respecting the displayed speed x	The signal can be passed at the speed displayed	Pass / Fail	
Test scenario ESC_L1LS_Erg_1 finished				

Note: If the steps 2 or/and 3 fail, the way of driving could be too aggressive or/and the braking curves could be too restrictive.

3.12.2 Scenario diagram

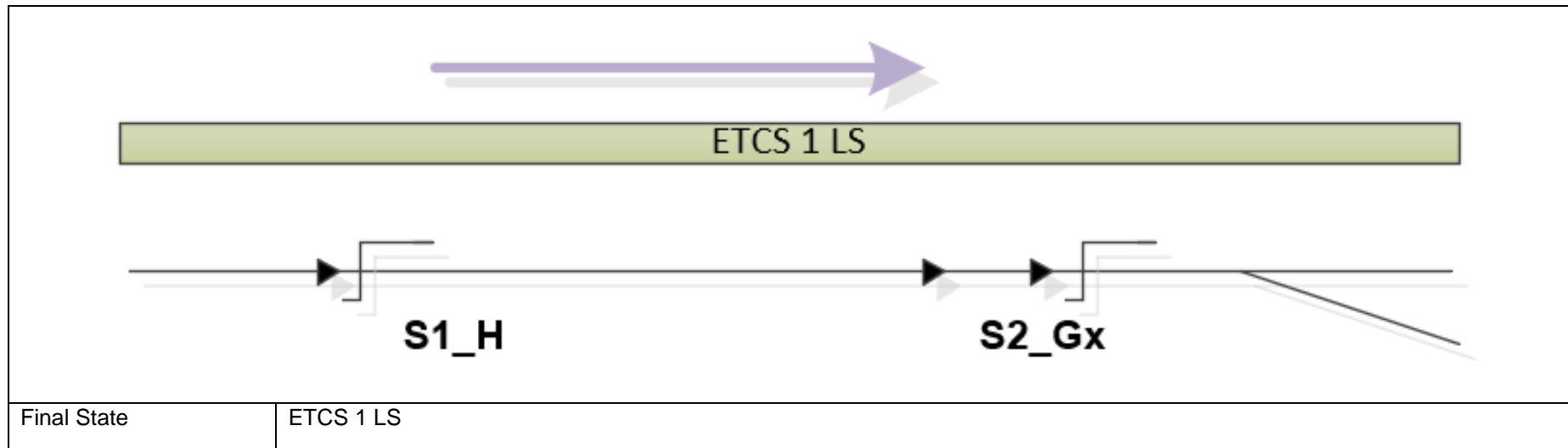

3.12.3 Note

For example: here are some locations where the test can be performed

Line	S1_H	S2_Gx	Speed reduction
15	A530	C-H.14	120->60
15	A451	M-G.14	120->60
L21ACD	GKX-E.14	FKX-E.14	120->60